



# Gas Mass Flow Meter vc.3

Model MF5700



# **Gas Mass Flow Meter**

**with MEMS thermal sensing technology**  
MF5700 Series

## **User Manual**

Document No. 11-2021-MF2 EN

Issue date: 2021.11

Revision: VC.3



 **Attention !**

- Please carefully read this manual prior to operating this product.
- Do not open or modify any hardware which may lead to irrecoverable damage.
- Do not use this product if you suspect any malfunctions or defection.
- Do not use this product for corrosive media or in a strong vibration environment.
- Use this product according to the specified parameters.
- Only the trained or qualified personnel shall be allowed to perform product services.

 **Use with caution !**

- Be cautious for the electrical safety, even it operates at a low voltage, any electrical shock might lead to some unexpected damages.
- The gas to be measured should be clean and free of particles. Do not apply this meter for liquid medium.
- Do not apply for any unknown or non-specified gases that may damage the product.
- For wireless data with NB-IoT, please be sure the network is available.



## Table of Contents

<b>1. Overview.....</b>	<b>5</b>
<b>2. Receipt / unpack of the products .....</b>	<b>6</b>
<b>3. Knowing the products .....</b>	<b>7</b>
3.1 Product description .....	7
3.2 LCD description.....	8
3.3 Power and data cable description .....	9
3.4 Mechanical dimensions.....	9
<b>4. Installation.....</b>	<b>11</b>
<b>5. Operation and MENU description.....</b>	<b>14</b>
5.1 Check the product specifications.....	14
5.2 Check the leakage .....	14
5.3 Power the meter and digital data connection.....	14
5.4 Wireless data communication.....	15
5.5 Meter MENU description.....	15
5.5.1 Starting the measurement .....	16
5.5.2 MENU entry with a verified password .....	16
5.5.3 Set the RS485 Modbus address.....	17
5.5.4 Set the RS485 communication baud rate.....	17
5.5.5 Reset or calibrate the offset .....	17
5.5.6 Gas conversion factor (GCF) for different gas measurement.....	18
5.5.7 Set the Response time .....	18
5.5.8 Select the display mode .....	19
5.5.9 Select the display language .....	19
5.5.10 Open/close the valve.....	19
5.5.11 Set an alarm: upper instant flow rate limit .....	20
5.5.12 Set an alarm: lower instant flow rate limit .....	20
5.5.13 Set an alarm: accumulated flow rate or totalizer limit.....	21
5.5.14 Change the default password .....	21



5.5.15	Reset the accumulated or totalized flow rate.....	22
5.5.16	Exit the MENU.....	22
5.5.17	Sleeping mode .....	22
5.5.18	Wake up the meter .....	22
5.5.19	MENU key sequence for the settings.....	23
5.6	RS485 Modbus communication protocol .....	24
5.6.1	Hardware connection.....	24
5.6.2	Communication parameters .....	24
5.6.3	Frame .....	25
5.6.4	Function codes .....	25
5.6.5	Registers.....	25
6.	Product selection and order information.....	29
6.1	Product selection .....	29
6.2	Order contact and customer support.....	29
7.	Technical specifications.....	30
8.	Technical notes for the product performance .....	31
8.1	Measurement principle .....	31
8.2	Precautions for the best performance of the product.....	31
8.2.1	Comparison with a third party reference meter.....	31
8.2.2	Particle contamination and fluidic cleanness .....	32
8.2.3	Apply to a different gas medium .....	32
9.	Troubleshooting .....	33
10.	Warranty and Liability.....	34
11.	Service contact .....	36
	Appendix I: Product evaluation kit.....	37
	Appendix II: Document history .....	38

## 1. Overview

All contact information can be found at the end of this manual.

This manual provides essential information for the operation of the MF5700 series of gas mass flow meters general-purpose gas metrology applications. The product performance, maintenance, and trouble-shooting as well as the information for product order, technical support, and repair are also included.

The MF5700 mass flow meter is one of the best-selling mass flow meter products on market, due to its performance and cost-effective design enabled with the company's proprietary MEMS (micro-electro-mechanical systems) thermal sensing technology. The current model is the 3<sup>rd</sup> generation of the products having significantly upgraded features since its first release in 2010. The upgrade includes much-improved accuracy, an additional model to cover flow range and channel size compatibility; significantly extended measurement dynamic range, wireless data options, and valve options. The upgrade also ensures back-compatibility for our existing customers. Tool is committed to continuing product innovation while offering the best value to our customers.

This serial of products is designed for general purpose mass flow sensing and control purposes. The wetted materials of the products are compatible with most of the common gases such as oxygen, nitrogen, air, argon, carbon dioxide, etc. Tool also offers a wide spectrum of off-the-shelf and customized flow, pressure, temperature/humidity, and gas concentration sensing products and provides integration and turn-key solutions to our customers. Please contact the manufacturer for additional information.

## 2. Receipt / unpack of the products

Upon receipt of the products, please check the packing box before the dismantlement of the packing materials. Ensure no damages during shipping. If any abnormality is observed, please contact and notify the carrier who shipped the product and inform the distributors or sales representatives if the order is not placed directly with the manufacturer, otherwise, the manufacturer should be informed as well. For any further actions, please refer to the return and repair section in this manual.

If the packing box is intact, proceed to open the packing box, and you shall find the product (either the meter or the meter with the valve per the actual order). The power adapter and/or data cable as shown below may also be found according to your actual order.

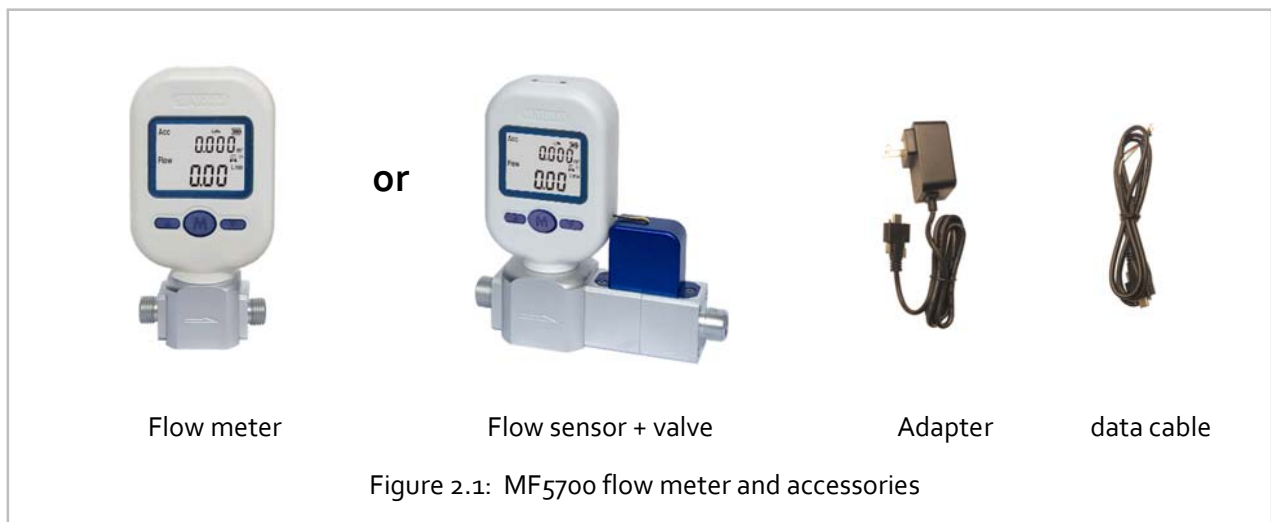

Please check immediately for the integrity of the product as well as the power and data cable, if any abnormal is identified, please notify the distributor/sales representative or manufacturer as soon as you can. If any defects are confirmed, an exchange shall be arranged immediately via the original sales channel. (Note: the LCD screen shall not be lighted until the battery is installed or the power cable is plugged in). This user manual shall also either be included in the packing box or via an online request for an electronic version. In most cases, this manual shall be made available to the customer before the actual order.

The meter is designed with low power that can be operated with 4 AA batteries. However, if you ordered the product with the control valve, it is recommended to have external power since the valve requires large power consumption. A power adapter must have a safety certification for use with this meter. The external power/data connector is a type-C USB. See the detailed requirements in the operation section.

### 3. Knowing the products

#### 3.1 Product description

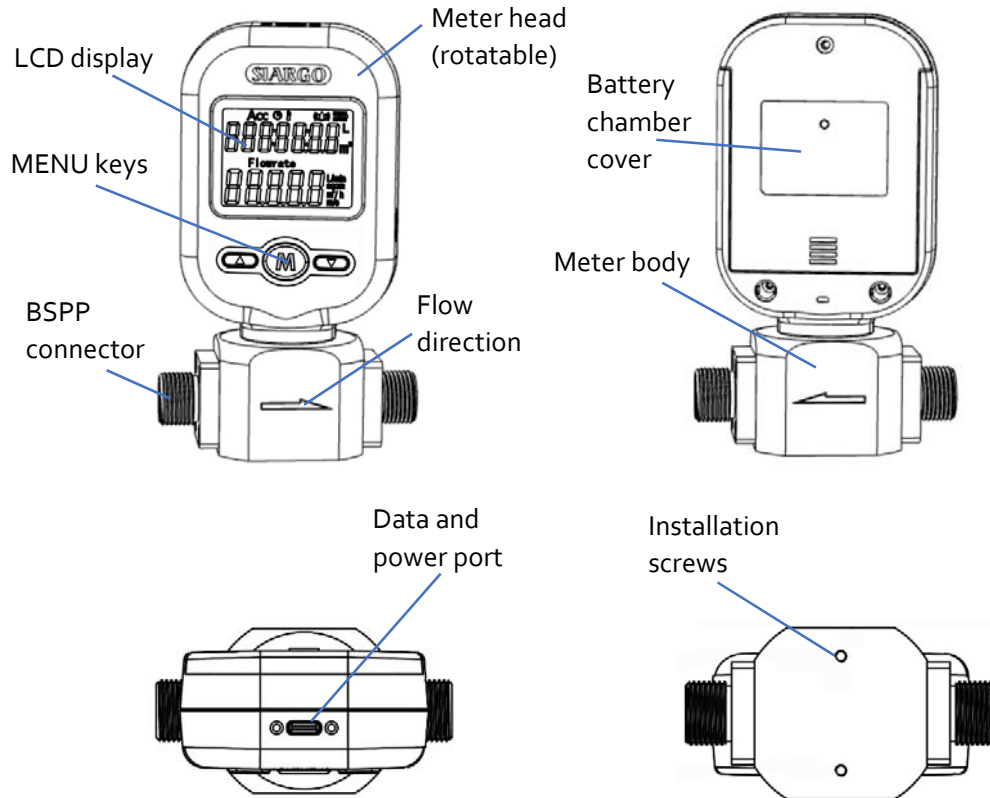

Figure 3.1: MF5700 parts description

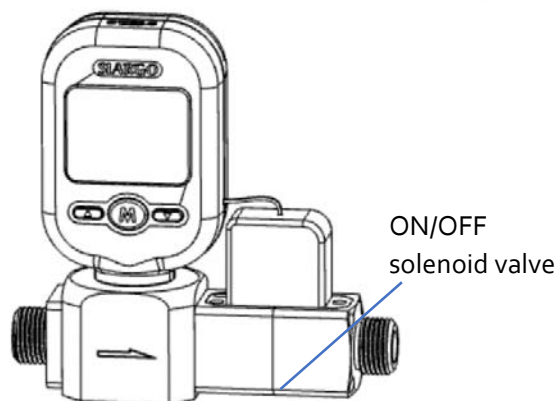

Figure 3.2: MF5700 with valve









### 3.2 LCD description



Figure 3.3: LCD symbol illustration.

The LCD provides all information that the product measures. Some symbols are reserved for future upgrades, and will not be lighted during the operation. The following table details the meaning of each of the symbols.

Table 3.1: Symbols description

<b>ACC</b>	The top row. The default displays the totalized flow rate in L (liters), m <sup>3</sup> (cubic meters), or SCF (standard cubic feet). It also displays pressure (if kPa lights up) or temperature (if °C lights up)*.
<b>Flow</b>	The 2 <sup>nd</sup> row. Displays instant flow rate in L/min (Liters per minute) or SCFH (standard cubic feet per hour) or m <sup>3</sup> /h (cubic meters per hour).
	Battery status.
	Valve status. The current product provides an ON/OFF control valve.
<b>LoRa</b>	LoRa wireless protocol is enabled when lights up.
	NB-IoT wireless protocol is enabled when lights up.
	WIFI wireless protocol is enabled when lights up.
	Bluetooth LE 4.2 wireless protocol is enabled when lights up.
	Reserved for future upgrade of GPRS inclusion.

**\*Note:** Both the pressure and temperature sensors can be integrated with the current product but not with the default models. Please contact the manufacturer for further information.

### 3.3 Power and data cable description

Table 3.2: MF5700 wire assignment.



Wire	Color	Definition
1	Red	Power supply (5~24 Vdc)
2	Black	GND, ground
3	Green	RS485A
4	White	RS485B

Figure 3.4: MF5700 cable (USB-C-100)

### 3.4 Mechanical dimensions

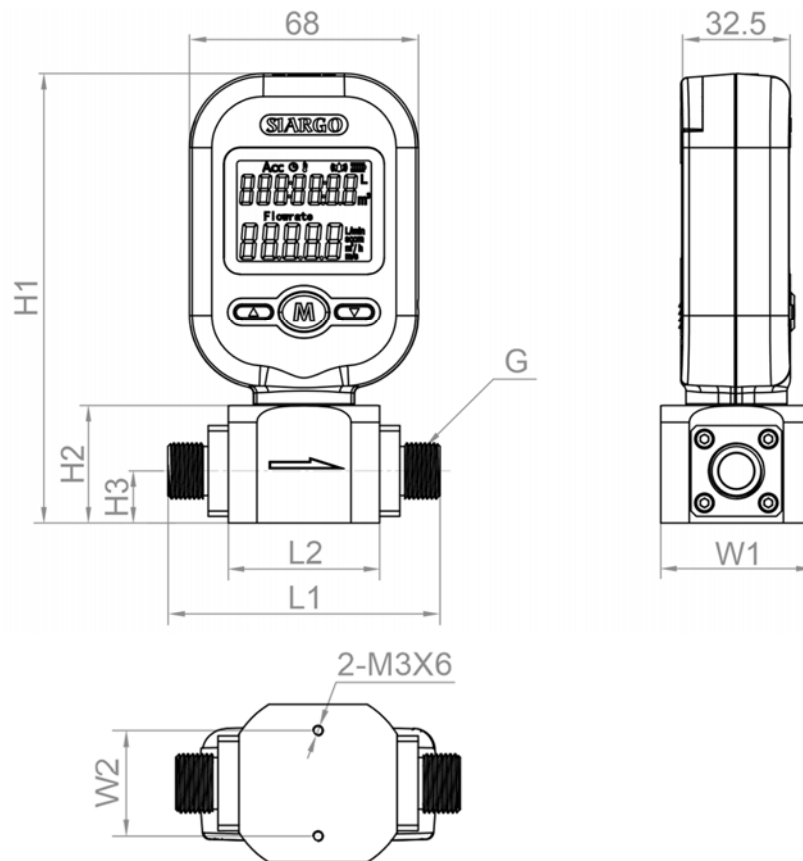

Figure 3.5: MF5700 meter dimensions

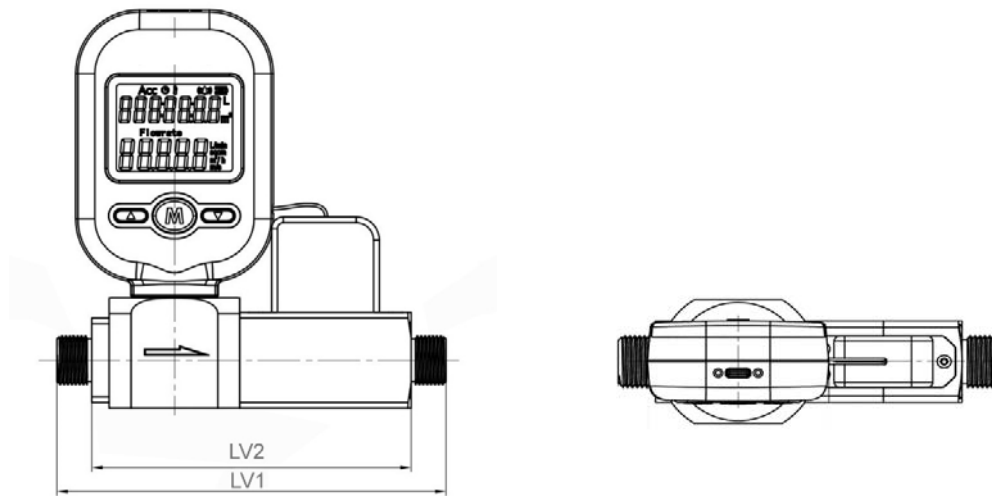

Figure 3.6: MF5700 meter with control valves dimensions

Table 3.3: Mechanical dimensions of the meters/meters with control valves

	Connector, G	L1	L2	LV1	LV2	W1	W2	H1	H2	H3
MF5706	BSPP 1/4"	61	34	95.5	123	34	25	127	28	12.5
MF5708	BSPP 3/8"	81	45	110	134	45	30	134	35	15.5
MF5712	BSPP 1/2"	90	50	115	143	45	30	141	42	19.5

## 4. Installation

Do not open or alter any part of the product which would lead to malfunction and irrecoverable damage. It will also forfeit the terms of the warranty and cause liability.

The product at the time of shipment is fully inspected for its quality and meets all safety requirements. Additional safety measures during the installation should be applied. This includes, but is not limited to the leakage verification procedures, standard EDS (electrostatic discharge) precautions, DC voltage precautions. Other tasks such as calibration, part replacement, repair, and maintenance must only be performed by trained personnel. Upon request, the manufacturer will provide necessary technical support and/or training of the personnel.

The product is preferable to be installed horizontally. Flow direction should be aligned with the arrow mark on the meter body. If the flowing fluid may have particles or debris, a filter is strongly recommended to be installed upstream of the meter.

Please follow the following steps to complete the installation:

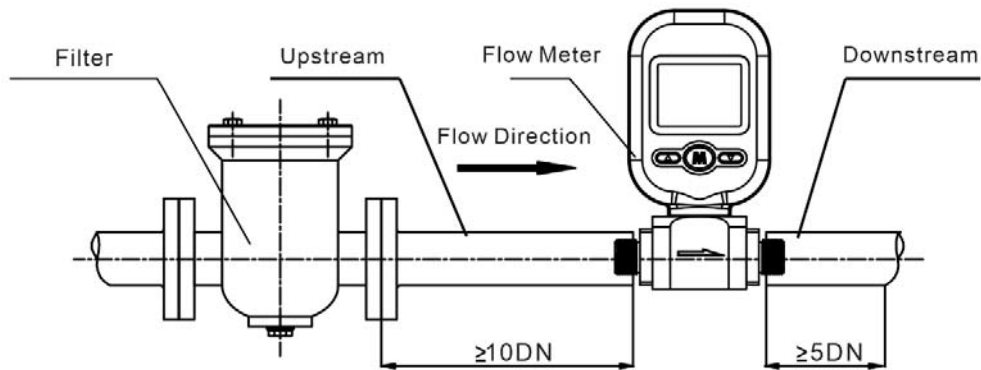

Figure 4.1: MF5700 meter installation

- a) Upon opening the package, the product's physical integrity should be inspected to ensure no visual damage.
- b) Before installation of the product, please ensure that the pipe debris or particles or any other foreign materials are completely removed.
- c) Cautions during installation:
  - (i) It is preferably to first install the inlet end of the meter and then the outlet end of the meter; To ensure the measurement accuracy, an upstream straight pipe of length no less than  $10DN$  and a downstream straight pipe of length no less than  $5DN$  should be in place. Please refer to the following recommended installation configuration.

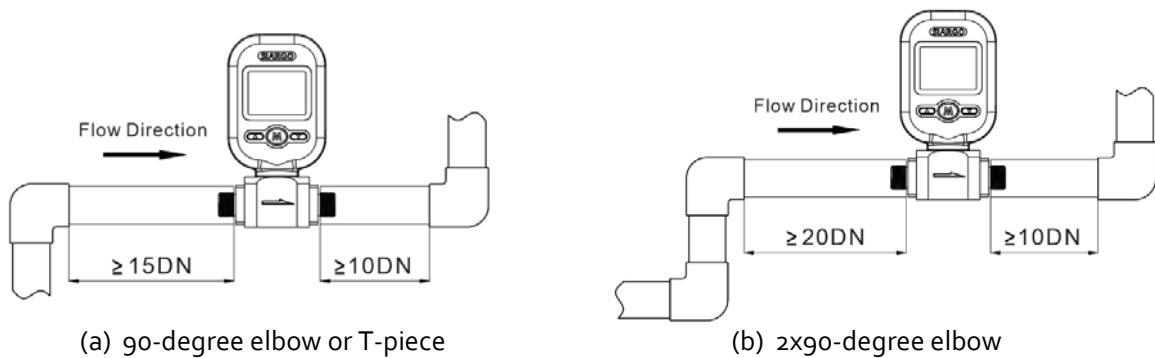

Figure 4.2: MF5700 meter installation

(ii) If the upstream or downstream pipe size is different from that of the product, the size of the installation line pipe diameter(s) should be larger than the flow channel (pipe) size of the meters to be installed. For some typical situations, please follow the installation recommendation detailed in the following sketches.

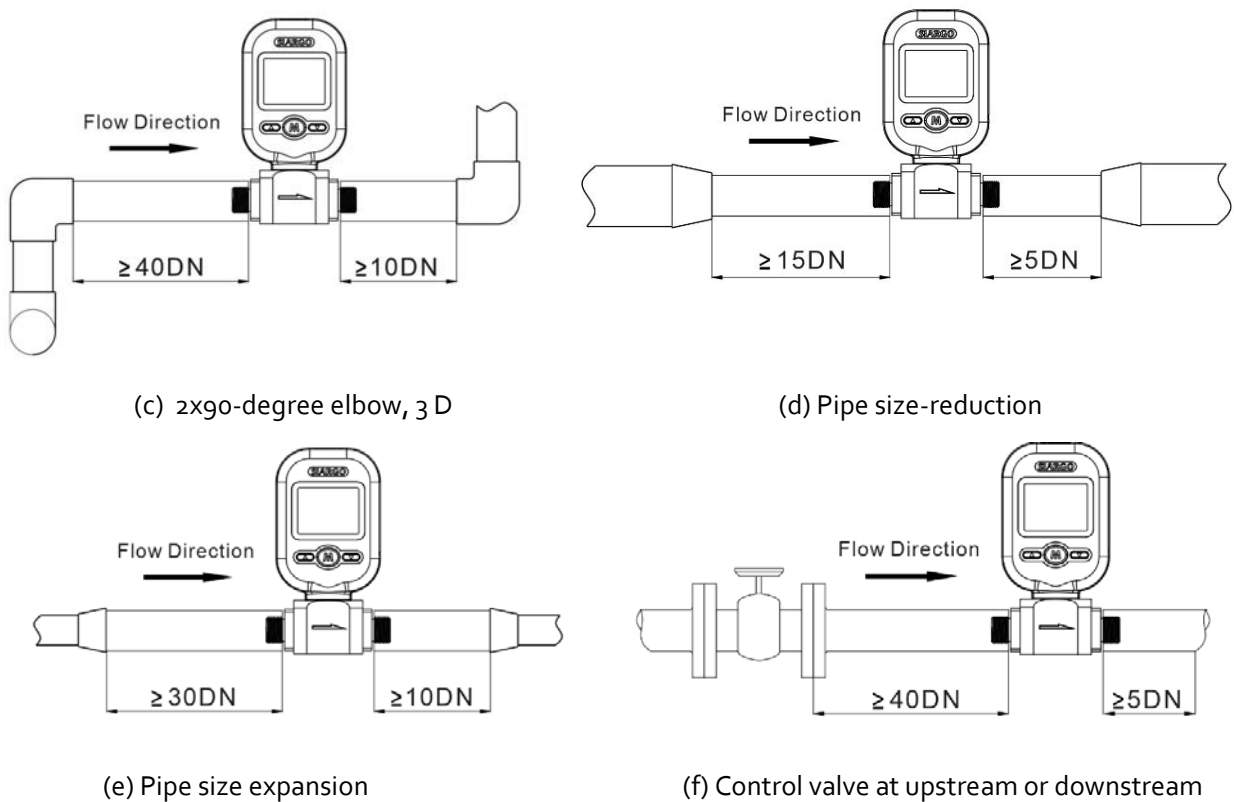

Figure 4.3: MF5700 meter installation

(iii) During installation, please make sure no foreign materials (such as water, oil, dirt, particles, etc.) enter into the installation pipeline.

- d) Install 4-AA batteries into the battery chamber. In case that the external power supply is desired, connect electrical wires per the wire definition in Table 3.2. Please be sure of the power supply range (i.e., 5 ~ 24 VDC) and power supply polarization. If an adapter other than the one supplied by the manufacturer, make sure the adapter meets industrial standards and has all safety certifications.
- e) For the communication wire connection, please follow the description in Table 3.2 and make sure that the wires are correctly connected to the proper ports on your data device/equipment. Please make sure the data cable meets industrial standards with proper shielding.
- f) Once the battery is installed, or the external power is successfully connected, the LCD should be lighted up with the proper information displayed works correctly.
- g) Slowly open the valve(s) if any, upstream or downstream or both of the pipeline, and the meter should then start to measure the flow in the pipeline.

**Note:** because the meter has a large dynamical measurement range, it could be normal if you see the small instant flow rate before you open the valve as there could be some leakage. However, make sure the meter reads null when there is no flow present in the pipeline.

- h) This will conclude the installation.



### Cautions

- a) Don't alter any parts of the product.
- b) Ensure the electrical connection is properly done per the instructions.
- c) Make sure no mechanical stresses in the connections.
- d) The strong electromagnetic interference sources close by or any mechanical shocks at the pipeline may also create malfunctioning of the product.
- e) Slowly open/close valves to prevent abrupt pulse flow impact.

## 5. Operation and MENU description

### 5.1 Check the product specifications

Before starting to use this product, check the product specifications that can be found in this manual or the basic information located on the back panel of the product.

The detailed product technical specifications can be found in Section 7. For a specific application, the pressure rating must not be higher than the system pressure to be measured, and the flow range should also be within the specified ones. In most cases, the use of a high full-scale ranged meter for the very low flow rate measurement often results in erroneous data. The gas to be measured must also be consistent with that specified by the product. Be particularly cautious about the supplied voltage indicated in the specification. A higher voltage may lead to irrecoverable damage, and a lower voltage will not power the product for any desired functions.

For the best performance of the product, it is advised that the gas to be measured must be clean and free of particles or other foreign materials.

### 5.2 Check the leakage

Check gas leakage before any measurement. If it is needed, the pressurized nitrogen or air can be used for the leakage check.

### 5.3 Power the meter and digital data connection

Although this product complies with the CE-required EMC regulations, it also requires the product to be used according to the standard electrical device practice. For general-purpose usage, the meter can be powered by 4 AA batteries. Be sure to select the batteries with safety proof and within the expiration date. Do not use batteries without a known manufacturer and expiration date. For models with control valves or for extensive usage, it is recommended to have the meter powered with external DC power or an AC-DC adapter. Make sure the supply voltage is within the range of the specified ones in Section 7. Before connecting the product with the external power, make sure the standard electrical device precautions such as ESD (electrostatic discharge) and DC voltage are observed. Excessive electrostatic discharge may damage the product.

The power and data are connected via a standard Type-C USB port. The manufacturer-supplied Type-C USB cable has the screw locking fixture. It is recommended such a feature to ensure the cable is properly engaged and will not be accidentally got unplugged.

Half-duplex RS485 Modbus is used for digital data communication. Make sure the wires are properly connected to the receiver side.

### 5.4 Wireless data communication

The product has optional wireless data transmission, including Bluetooth LE 4.2, LoRa, WIFI, and NB-IoT wireless data.

An application APP named "Tool Smart Meter 2.0" can be downloaded from either Apple Store for smart devices based on the iOS system or from Google Play Store for smart devices based on the Android system.

The APP provides the basic functions to access the meter/sensor data, plot an instant flow rate chart, calculate totalized or accumulated flow volume at a specific time defined by the user. It allows the user to send the local data instantly to a remote destination when the wired connection is not an option. Also, the interface provides the readout of the product information as well as technical support information.

For the detailed protocols of LoRa, WIFI, and NB-IoT, please contact the manufacturer for further information.

### 5.5 Meter MENU description

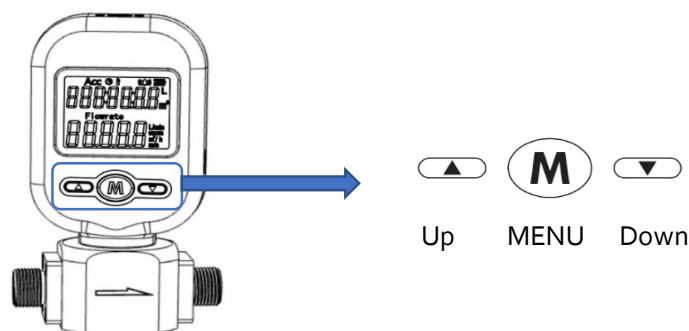

The meter has a front 3-key board for the user to set the desired functions, access data, and check for the status. The Menu key (M) is at the central position that allows the user to select a function and confirmation or other related actions that will be detailed below. Two keys ("Up" and "Down") to select the menu and sub-menu.



### 5.5.1 Starting the measurement



Once the power is supplied and no abnormal issues are observed, the meter is ready to perform the measurements. The default display is for the mass flow measurement having two numerical lines on the LCD. The upper line is the accumulated or totalized flow rate, and the lower line is the instant flow rate. If the battery symbol turns into , proceed to change the battery or plug in the external power cord.

### 5.5.2 MENU entry with a verified password

At the flow measurement (main) display, press the central “M” MENU key, it will enter into the password setting and verification MENU. The default password is “11111”. If the password is incorrect, the display will return to the main display.

To enter a new password, press the “Up” or “Down” key to change the digit that flashes, and press the “M” key to confirm. Repeat this process for all 5 digits and the meter will enter into the menu setting interfaces/screen.

Subsequently, the MENU allows the user to:

- |   |             |
|---|-------------|
| ➤ Set Modbus address                                    | F2 - Addr   |
| ➤ Change communication baud rate                        | F3 - bPS    |
| ➤ Reset or calibrate the offset                         | F11 - oFFST |
| ➤ Enter the gas conversion factor (GCF)                 | F12 - GCF   |
| ➤ Change the response time                              | F16 - rESPS |
| ➤ Change the display mode                               | F38 - dISP  |
| ➤ Change the display language                           | F39 - LAnG  |
| ➤ Open/Close the valve                                  | F43 - VALVE |
| ➤ Set upper flow rate limit alarm                       | F51 - ALM-H |
| ➤ Set lower flow rate limit alarm                       | F52 - ALM-L |
| ➤ Set totalized or accumulated flow rate alarm          | F53 - ALM-A |
| ➤ Change the default password                           | F91 - PASS  |
| ➤ Clear or reset the totalizer or accumulated flow rate | F92 - CLr-A |
| ➤ Exit from the MENU                                    | F99 - qUIT  |

**Note:** During this process, the meter will continue to measure the flow without being interrupted.

### 5.5.3 Set the RS485 Modbus address



After the password is verified and entered into the MENU settings, press the "Up" or "Down" key until the screen shows the F2 - Addr as indicated to the left.

The Modbus address has 3 digits, which can be any number between 001 to 255. Press the "M" key to enter into the change address screen. Press the "Up" or "Down" key to change the flashing digits, and then press the "M" key to confirm. After the address is set, the display will return to F2 - Addr, which indicates the task is completed. Press the "Up" or "Down" key to select F99 - qUIT and the "M" key to exit the MENU and return to the Main Display screen.

### 5.5.4 Set the RS485 communication baud rate



Following the above-mentioned steps, at the MENU setting screen, use the "Up" or "Down" key to select F3 - bPS and then press the "M" key to set the RS485 communication baud rate.

There are 6 baud rates selectable, depending on your system requirements: 4800, 9600, 19200, 38400, 57600, and 115200. The default baud rate is 9600. Use the "Up" or "Down" key to select the desired one and press the "M" key to confirm. The display will then return to the F3 - bPS screen, which indicates the task is completed.

Use the "Up" or "Down" key to select F99 - qUIT and the "M" key to exit the MENU and return to the Main Display screen.

### 5.5.5 Reset or calibrate the offset



After a certain time of usage, the meter's offset (zero flow rate) might or might not have a small shift. Or when you apply the meter for different gases, the offset might be shifted. To ensure measurement accuracy, it is necessary to reset or calibrate the offset. Following the above-mentioned steps, at the MENU setting screen, use the "Up" or "Down" key to select F11 - oFFST. Before performing the task, make sure there is absolutely no flow in the flow channel, otherwise, it will create even bigger erroneous measurement results.

Press the "M" key to confirm the task, and it will open the sub-MENU asking you to confirm. Use the "Up" or "Down" key to select the desired one and press the "M" key to confirm. The display will then return to the F11 - oFFST screen, which indicates the task is completed. Use the "Up" or "Down" key to select F99 - qUIT and the "M" key to exit the MENU and return to the Main Display screen.

### 5.5.6 Gas conversion factor (GCF) for different gas measurement



For the general purpose of the application, a gas conversion factor (GCF) can be applied to meter the gas different from the default one or the one used for calibration. The GCF is determined by the thermal calorimetric sensing principle as well as the meter fluidic dynamic design and the control circuitry. Contact the manufacturer to obtain the values corresponding to the correct models.

The GCF for air is 1000.

**Note: If the meter during purchase is ordered for a special real gas calibration, contact the manufacturer before further proceeding.**

Following the above-mentioned steps, at the MENU setting screen, use the "Up" or "Down" key to select F12 - GCF. Press the "M" key to confirm, and it will open the sub-MENU showing the current gas conversion value. Use the "Up" or "Down" and the "M" confirming key to input the desired value, and press the "M" key again to complete the task. The display will then return to the F12 - GCF screen, which indicates the task is completed. Use the "Up" or "Down" key to select F99 - qUIT and the "M" key to exit the MENU and return to the Main Display screen.

### 5.5.7 Set the Response time



Following the above-mentioned steps, at the MENU setting screen, use the "Up" or "Down" key to select F16 - rESPS and then press the "M" key to set the response time.

There are 6 response time selectable: 125, 250, 500, 1000, 2000, and 5000, unit is msec. The default response time is 125 msec. Use the "Up" or "Down" key to select the desired one and press the "M" key to confirm. The display will then return to the F16 - rESPS screen, which indicates the task is completed. Use the "Up" or "Down" key

to select F99 - qUIT and the "M" key to exit the MENU and return to the Main Display screen.

### 5.5.8 Select the display mode



This function is to set the display modes, cycle display mode, or fixed display mode. If one likes to switch between these two display modes, following the above-mentioned steps, at the MENU setting screen, use the "Up" or "Down" key to select F38 - dISP. Press the "M" key to confirm, and it will open the sub-MENU showing the current display mode. Use the "Up" or "Down" and the "M" confirming key to select the desired one, and press the "M" key again to complete the task. The display will then return to the F38 - dISP screen, which indicates the task is completed. Use the "Up" or "Down" key to select F99 - qUIT and the "M" key to exit the MENU and return to the Main Display screen.

### 5.5.9 Select the display language



This function is reserved for future upgrades. The current models are configured to be English or Chinese based on the shipping geographic regions. However, if one likes to switch between these two default languages, following the above-mentioned steps, at the MENU setting screen, use the "Up" or "Down" key to select F39 - LANg. Press the "M" key to confirm, and it will open the sub-MENU showing the current language. Use the "Up" or "Down" and the "M" confirming key to select the desired one, and press the "M" key again to complete the task. The display will then return to the F39 - LANg screen, which indicates the task is completed. Use the "Up" or "Down" key to select F99 - qUIT and the "M" key to exit the MENU and return to the Main Display screen.

### 5.5.10 Open/close the valve



This function is to open or close the valve. If one likes to open or close the valve, following the above-mentioned steps, at the MENU setting screen, use the "Up" or "Down" key to select F43 - VALVE. Press the "M" key to confirm, and it will open the sub-MENU showing the current valve status. Use the "Up" or "Down" and the "M" confirming key to select the desired one, and press the "M" key again to complete the task. The display will then return to the F43 - VALVE screen, which indicates the task is completed. Use the "Up" or "Down" key to select F99 - qUIT and the "M" key to exit the MENU and return to the Main Display screen.

### 5.5.11 Set an alarm: upper instant flow rate limit



This function allows the user to set the instant flow rate above which the meter will trigger the alarm function. The alarm will be a sharp sound every 2 seconds while the screen/display will flash. The triggered alarm will not stop the meter from the continuous operation. The alarm will be off once the metering value is below the set value.

The flow rate has two decimal points with a maximum not over the full-scale flow rate at the order. Following the above-mentioned steps, at the MENU setting screen, use the "Up" or "Down" key to select F51 - ALM-H. Press the "M" key to confirm, and it will open the sub-MENU showing a default flow rate of 999.99. Use the "Up" or "Down" and the "M" confirming key to enter the desired one, and press the "M" key again to complete the task. The display will then return to the F51 - ALM-H screen, which indicates the task is completed. Use the "Up" or "Down" key to select F99 - qUIT and the "M" key to exit the MENU and return to the Main Display screen.

### 5.5.12 Set an alarm: lower instant flow rate limit



This function allows the user to set the instant flow rate below which the meter will trigger the alarm function. The alarm will be a sharp sound every 2 seconds while the screen/display will flash. The triggered alarm will not stop the meter from the continuous operation. The alarm will be off once the metering value is above the set value.

The flow rate has two decimal points with a minimum of 0.00. Following the above-mentioned steps, at the MENU setting screen, use the "Up" or "Down" key to select F52 - ALM-L. Press the "M" key to confirm, and it will open the sub-MENU showing a default flow rate of 0.00. Use the "Up" or "Down" and the "M" confirming key to enter the desired one, and press the "M" key again to complete the task. The display will then return to the F52 - ALM-L screen, which indicates the task is completed. Use the "Up" or "Down" key to select F99 - qUIT and the "M" key to exit the MENU and return to the Main Display screen.

### 5.5.13 Set an alarm: accumulated flow rate or totalizer limit



This function allows the user to set the maximum accumulated or totalized flow rate above which the meter will trigger the alarm function. The alarm will be a sharp sound every 2 seconds while the screen/display will flash. The triggered alarm will not stop the meter from the continuous operation. The alarm will be off by resetting the setting.

The accumulated or totalized flow rate has seven digits with a maximum of 9999999. Following the above-mentioned steps, at the MENU setting screen, use the "Up" or "Down" key to select F53 - ALM-A. Press the "M" key to confirm, and it will open the sub-MENU showing a default flow rate of 9999999. Use the "Up" or "Down" and the "M" confirming key to enter the desired one, and press the "M" key again to complete the task. The display will then return to the F53 - ALM-A screen, which indicates the task is completed. Use the "Up" or "Down" key to select F99 - qUIT and the "M" key to exit the MENU and return to the Main Display screen.

### 5.5.14 Change the default password

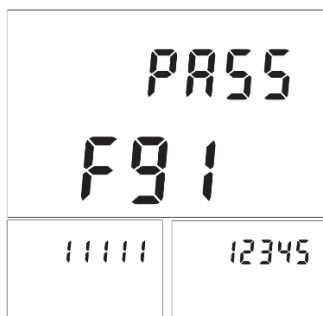

For data safety, it is recommended that the default password of 11111 should be changed when the first use of this product.

Following the above-mentioned steps, at the MENU setting screen, use the "Up" or "Down" key to select F91 - PASS. Press the "M" key to confirm, and it will open the sub-MENU showing the default password of 11111. Use the "Up" or "Down" and the "M" confirming key to enter the desired one, and press the "M" key again to complete the task. The display will then return to the F91 - PASS screen, which indicates the task is completed. Use the "Up" or "Down" key to select F99 - qUIT and the "M" key to exit the MENU and return to the Main Display screen.

Please keep the changed password in a safe yet accessible place. In case it is unrecoverable, please contact the manufacturer to obtain a special password to access the meter MENU.

### 5.5.15 Reset the accumulated or totalized flow rate



As the maximum value of the accumulated or totalized flow rate that the internal register can have is 9999999, the register will stop accumulating once the value is reached. At this time, it is necessary to reset this register. Following the above-mentioned steps, at the MENU setting screen, use the "Up" or "Down" key to select F92 - CLr-A. Press the "M" key to confirm, and it will open the sub-MENU for resetting the value. Use the "Up" or "Down" to select and the "M" confirming key to execute, and press the "M" key again to complete

the task. The display will then return to the F92 - CLr-A screen, which indicates the task is completed. Use the "Up" or "Down" key to select F99 - qUIT and the "M" key to exit the MENU and return to the Main Display screen.

### 5.5.16 Exit the MENU

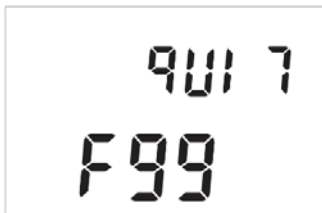

At the MENU settings, use the "Up" or "Down" key to select the F99 - qUIT option and press the "M" confirming key to exit the MENU settings and return to the Main Display screen.

### 5.5.17 Sleeping mode

When the meter is powered by batteries, it is necessary to enable the sleeping mode for the power saving to allow a longer operation time.

The meter is programmed with an automatic sleeping mode that will automatically shut off the display and the control circuitry is at minimal power consumption. This mode will be executed when the continuously measured flow rate is zero for 5 minutes.

The meter can also be turned into the sleep mode manually via pressing the "Up" key for 3 seconds.

### 5.5.18 Wake up the meter

When the meter is in sleeping mode, it will be automatically wake up if the flow rate in the flow channel is larger than 0.5 L/min (1.1 SCFH or 0.03 m<sup>3</sup>/h) for 10 seconds. Or the meter can be waked up manually by pressing any of the three keys in the front meter face.

### 5.5.19 MENU key sequence for the settings

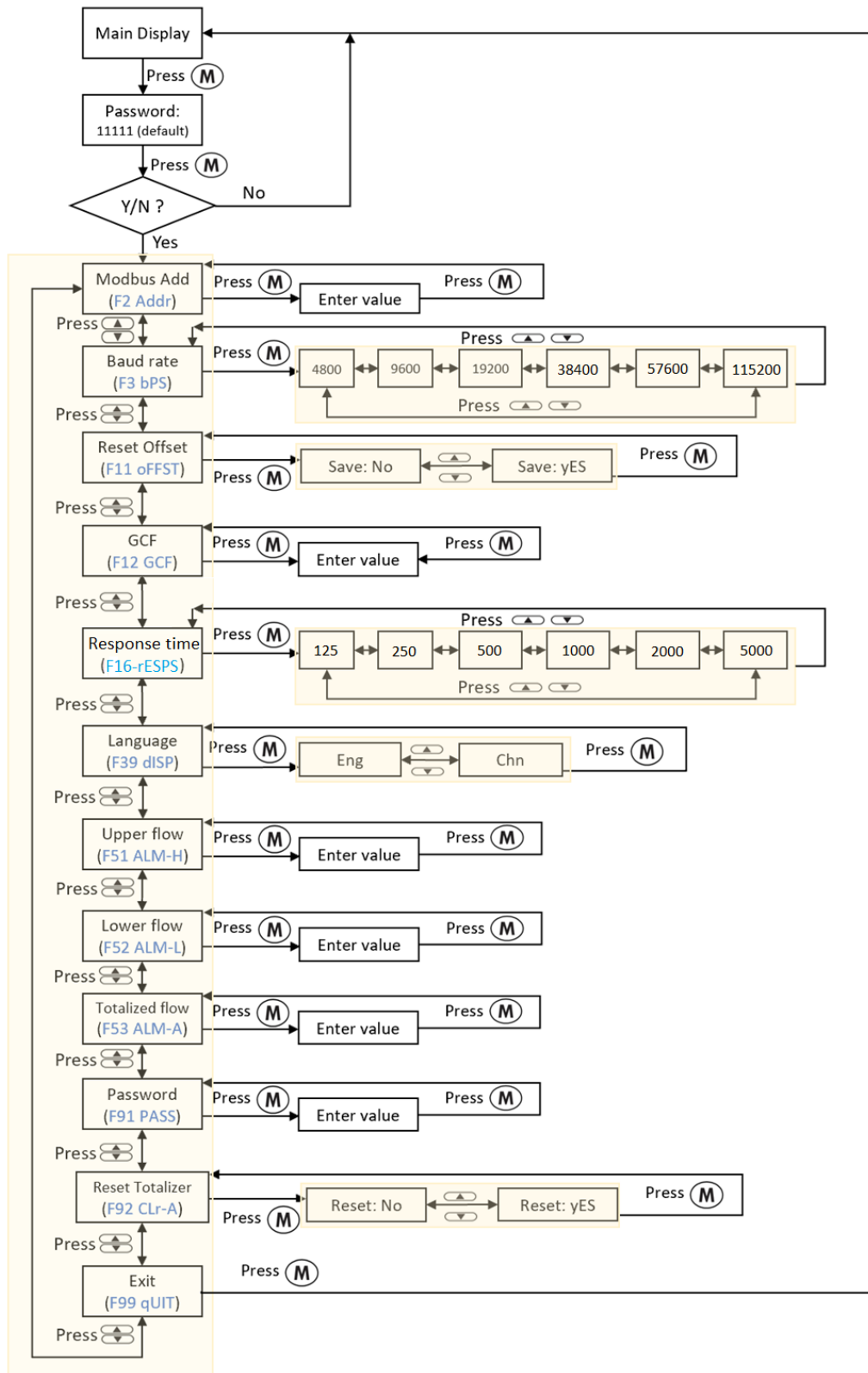



## 5.6 RS485 Modbus communication protocol

The digital communication protocol is based on standard Modbus RTU Half-plex mode. A master (PC or PLC) can communicate with multiple slaves (the current product) for data exchange and communication parameter configuration.

### 5.6.1 Hardware connection

The hardware layer is TIA/EIA-485-A, as illustrated below. In this configuration, the product (MF5700) is a slave.

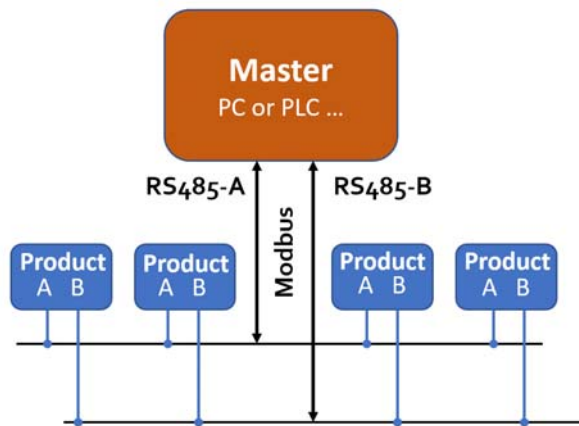

### 5.6.2 Communication parameters

The PC UART communication parameters are listed in the following table.

Parameters	Protocol
	RTU
Baud rate (Bits per second)	9600 bps
Start bits	1
Data bits	8
Stop bits	1
Even/Odd parity	None
Bits period	104.2 $\mu$ sec
Bytes period	1.1458 msec
Maximum data length	20
Maximum nodes	247

### 5.6.3 Frame

The frame function is based on the standard Modbus RTU framing:

Start_bits	Address	Function codes	Data	CRC	Stop_bits
T1-T2-T3-T4	8 bit	8 bit	N 8 bit (20≥n≥0)	16 bit	T1-T2-T3-T4

**Start\_bits:** 4 periods bit time, for a new frame.

**Address:** The address can be set from 1 to 255 except for 157 (0x9d). 0 is the broadcast address.

**Function codes:** Define the product (MF5700)'s functions/actions (slaves), either execution or response.

**Data:** The address of the register, length of data, and the data themselves.

**CRC:** CRC verification code. The low byte is followed by the high byte. For example, a 16 bit CRC is divided into BYTE\_H and BYTE\_L. In the framing, the BYTE\_L will come first, then followed by the BYTE\_H. The last one is the STOP signal.

**Stop\_bits:** 4 periods bit time, for ending the current frame.

### 5.6.4 Function codes

The Modbus function codes applied for the product are the sub-class of the standard Modbus function codes. These codes are used to set or read the registers of the product:

Code	Name	Functions
0x03	Read register	Read register(s)
0x06	Set single register	Write one single 16-bit register
0x10	Set multiple registers	Write multiple registers

### 5.6.5 Registers

The product (MF5700) has multiple registers available for the assignment of the various functions. With these functions, the user can obtain the data from the products, such as *product address* and *flow rates* from the registers, or set the product functions by writing the corresponding parameters.

The currently available registers are listed in the following table, and the registers may be customized upon contacting the manufacturer. Where R: read; W: write-only; W/R: read and write.

**Note:** At the time of shipping, the write protection function is enabled except for address and baud rate. Once the user completes the register value change, the write protection will be automatically enabled once again to prevent incidental data loss.

Functions	Description	Register	Modbus reference
Address	Product address (R/W)	0x0081	40130 (0x0081)
Serial number	Serial number of the product	0x0030	40049 (0x0030)
Flow rate	Current flow rate (R)	0x003A~0x003B	40059 (0x003A)
Accumulated flow	Accumulated or totalized flow rate (R)	0x003C~0x003E	40061 (0x003C)
Baud rate	Communication (R/W)	0x0082	40131 (0x0082)
GCF	Gas correction factor (R/W)	0x008B	40140 (0x008B)
Response time	Set the response time (R/W)	0x008D	40142 (0x008D)
Totalizer alarm	Accumulated/totalized flow rate alarm (R/W)	0x0096~0x0097	40151 (0x0096)
Upper flow alarm	Upper flow rate limit alarm (R/W)	0x0098~0x0099	40153 (0x0098)
Lower flow alarm	Lower flow rate limit alarm (R/W)	0x009A~0x009B	40155 (0x009A)
Password	Password change (R/W)	0x00AE~0x00AF	40175 (0x00AE)
Offset calibration	Offset reset or calibration (W)	0x00F0	40241 (0x00F0)
Reset totalizer	Reset accumulated or totalized flow rate (W)	0x00F2	40243 (0x00F2)
Write protection	Write protection of selected parameters (W)	0x00FF	40256 (0x00FF)

The detailed information of each register is described below: Y: enabled; N: disabled

<b>Flowmeter address</b>	<b>0x0081</b>	<b>Write</b>	Y
		<b>Read</b>	Y
<b>Description</b>	Address of the product		
<b>Value type</b>	UINT 16		
<b>Notes</b>	Values from 1 to 255 except for 157 (0x9d). 0 is the broadcast address.		

<b>SN, Serial number</b>	<b>0x0030</b>	<b>Write</b>	N
		<b>Read</b>	Y
<b>Description</b>	Series Number of the product, SN		
<b>Value type</b>	UINT8 (12 bits)		
<b>Notes</b>	SN= value(0x0007), value(0x0008),...,value (0x000C); Receiving 12 bits as: 2A 47 37 41 45 49 30 32 30 35 38 2A , the corresponding Serial Number is *G7AEI02058*.		

<b>Current flow rate</b>	<b>0x003A ~ 0x003B</b>	<b>Write</b>	N
		<b>Read</b>	Y
<b>Description</b>	Current flow rate		
<b>Value type</b>	UINT 16		
<b>Notes</b>	Flow rate = [Value (0x003A)*65536 + value (0x003B)]/1000 e.g.: for a flow rate of 20.340 SLPM, the user will read "0" from register 0x003A and "20340" from register 0x003B, therefore Current flow rate = (0*65536+20340)/1000 = 20.340		

<b>Accumulated flow rate</b>	<b>0x003C ~ 0x003E</b>	<b>Write</b>	N
		<b>Read</b>	Y
<b>Description</b>	Accumulated or totalized flow rate		

<b>Value type</b>	UINT <sub>32</sub> + UNIT <sub>16</sub>
<b>Notes</b>	Accumulated flow rate $= \text{Value (0x003C)} * 65536 + \text{Value (0x003D)} + \text{Value (0x003E)}/1000$ e.g.: for an accumulated flow rate of 3452.245 m <sup>3</sup> , the user will read "0" from register 0x003C; "3452" from register 0x003D, and "245" from register 0x003E. Then, the accumulated flow rate = 0 + 3425 + 245/1000=3425.245.

<b>Baud rate</b>	<b>0x0082</b>	<b>Write</b>	Y
		<b>Read</b>	Y
<b>Description</b>	Communication baud rate with a PC		
<b>Value type</b>	UINT <sub>16</sub>		
<b>Notes</b>	0 - 4800; 1 - 9600; 2 - 19200; 3 - 38400; 4 - 57600; 5 - 115200. The default value is 1, the baud rate is 9600. For example, when the user reads "2" from register 0x0082, the baud rate is 19200.		

<b>GCF</b>	<b>0x008B</b>	<b>Write</b>	Y
		<b>Read</b>	Y
<b>Description</b>	The gas conversion factor for a gas that is different from the calibration gas.		
<b>Value type</b>	UINT <sub>16</sub>		
<b>Notes</b>	The air (default) is 1000, normally read from register 0x008B. <b>The product will disable this function with write protection once the metering gas is confirmed with the proper GCF.</b> <b>For a specific GCF value, please contact the manufacturer.</b>		

<b>Response time</b>	<b>0x008D</b>	<b>Write</b>	Y
		<b>Read</b>	Y
<b>Description</b>	Set response time		
<b>Value type</b>	UINT <sub>16</sub>		
<b>Notes</b>	125, 250, 500, 1000, 2000, or 5000, unit is msec. The default value is 125 msec. For example, when the user reads "2000" from register 0x008D, the response time is 2000 msec (2 sec).		

<b>Alarm: Accumulated flow rate</b>	<b>0x0096 ~ 0x0097</b>	<b>Write</b>	Y
		<b>Read</b>	Y
<b>Description</b>	Alarm set for the maximum value of an accumulated flow rate		
<b>Value type</b>	UINT <sub>32</sub>		
<b>Notes</b>	Alarm values = Value (0x0096)*65536 + Value (0x0097) When the set value is reached, an alarm will be triggered.		

<b>Alarm: Upper limited of a flow rate</b>	<b>0x0098 ~ 0x0099</b>	<b>Write</b>	Y
		<b>Read</b>	Y

<b>Description</b>	Set alarm value for an upper flow rate limit		
<b>Value type</b>	UINT <sub>32</sub>		
<b>Notes</b>	Alarm values = Value (0x0098)*65536 + Value (0x0099) When the flow rate is above a set value, an alarm will be triggered.		

<b>Alarm: Lower limit of a flow rate</b>	<b>0x009A ~ 0x009B</b>	<b>Write</b>	Y
		<b>Read</b>	Y
<b>Description</b>	Set alarm value for a lower flow rate limit		
<b>Value type</b>	UINT <sub>32</sub>		
<b>Notes</b>	Alarm values = Value (0x009A)*65536 + Value (0x009B) When the flow rate is below a set value, an alarm will be triggered.		

<b>Change password</b>	<b>0x00AE ~ 0x00AF</b>	<b>Write</b>	Y
		<b>Read</b>	Y
<b>Description</b>	Change the default password		
<b>Value type</b>	UINT <sub>32</sub>		
<b>Notes</b>	Password values = Value (0x00AE)*65536 + Value (0x00AF) Available: 00000 ~ 99999		

<b>Offset calibration</b>	<b>0x00F0</b>	<b>Write</b>	Y
		<b>Read</b>	N
<b>Description</b>	Reset or calibrate the offset		
<b>Value type</b>	UINT <sub>16</sub> , Fixed value 0xAA55		
<b>Notes</b>	To reset or calibrate the offset, write 0xAA55 to register 0x00F0. <b>When you execute this function, make sure there is NO flow in the flow channel.</b>		

<b>Reset accumulated flow rate</b>	<b>0x00F2</b>	<b>Write</b>	Y
		<b>Read</b>	N
<b>Description</b>	Reset the accumulated or totalized flow rate value		
<b>Value type</b>	UINT <sub>16</sub> , Fixed value 0x0001		
<b>Notes</b>	To reset the accumulated or totalized flow rate value, write 0x0001 to register 0x00F2.		

<b>Write protection</b>	<b>0x00FF</b>	<b>Write</b>	Y
		<b>Read</b>	N
<b>Description</b>	Write protection disabler for a set value to a specific register.		
<b>Value type</b>	UINT <sub>16</sub> , Fixed value 0xAA55		
<b>Notes</b>	This function is enabled at the time of product shipment. To enable the write function of a specific parameter, such as GCF, the user needs to send 0xAA55 to the register 0x00FF, and then the write function will be enabled (write protection is disabled). After the write execution is completed, the firmware will automatically re-enable the write protection.		

## 6. Product selection and order information

### 6.1 Product selection

The product part number is composed of the product model number and suffixes indicating the full-scale flow rate, as well as the other parameters. Refer to the following for details.

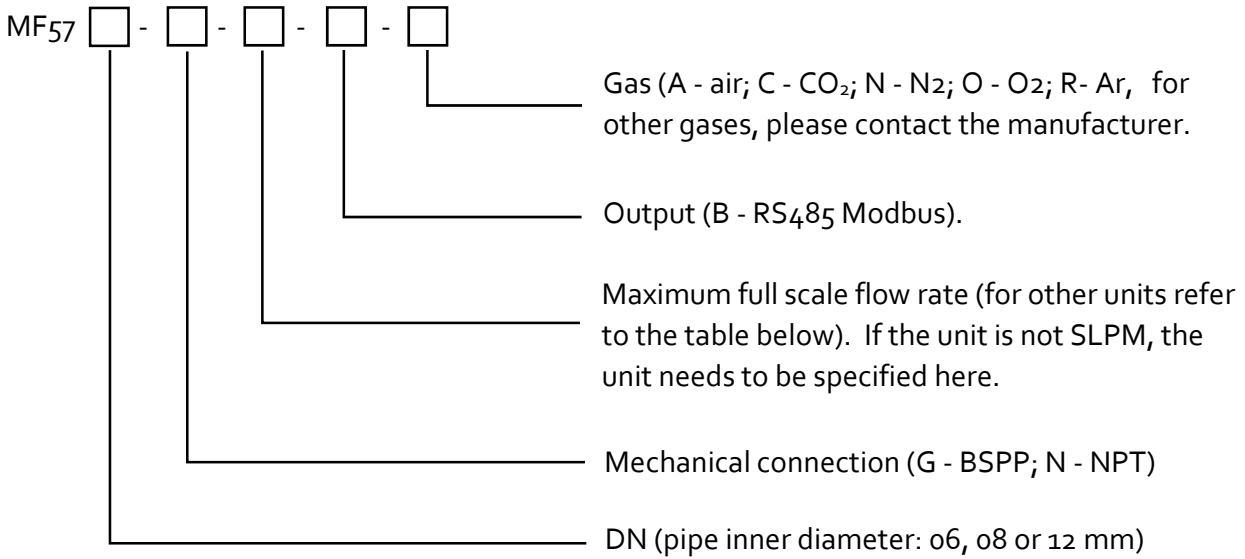

Table 6.1: Units conversion table

Model	DN (mm)	Connection	Maximum full-scale flow rate		
			SLPM	SCFH	NCMH
MF5706	6.0	BSPP 1/4" or NPT 1/4"	20	40	1.2
MF5708	8.0	BSPP 3/8" or NPT 3/8"	100	200	6
MF5712	12.0	BSPP 1/2" or NPT 1/2"	250	500	15

### 6.2 Order contact and customer support

The sales offices and the sales distributors/representatives are listed at the end of this document. For small quantities, the order can be placed either through the Tool website: [www.Tool.com](http://www.Tool.com) or the sales office. For large quantities, please contact the sales office, distributors, or sales representatives.

Tool is making every effort to ensure the quality of the products. In case of questions and/or product supports, please contact the customer service listed at the end of the document.

## 7. Technical specifications

All specifications listed in the following table unless otherwise noted apply for calibration conditions at 20°C and 101.325 kPa absolute pressure with air. The product is horizontally mounted at calibration.

	MF5706	MF5708	MF5712	Unit
Full-scale flow range	0~20	0~100	0~250	SLPM
Accuracy	±(2.0+0.5FS)			%
Repeatability	0.5			%
Turn-down ratio	80:1			
Response time	<2.0			sec
Working temperature	-10~55			°C
Maximum pressure	0.8			MPa
Humidity	<95, no condensation			%RH
Maximum overflow	100	200	400	SLPM
Maximum flow change	15	30	60	SLPM/sec
Pressure loss	0.6	1.0	2.0	kPa
Power supply	4-AA batteries (LR6) / 5~24 Vdc			
Power consumption	>60 (on batteries)			day
Power / data interface	USB Type-C			
Digital output	RS485 Modbus half-duplex			
Wireless options	LoRa / WIFI / NB-IoT / BT LE			
Display	LCD			
Resolution	0.01 L/min (instant) / 1 L (accumulated)			
Mechanical connection	BSP 1/4 or NPT 1/4"	BSP 3/8" or NPT 3/8"	BSP 1/2" or NPT 1/2"	
Storage temperature	-20 ~ 70			°C
Reference conditions	20°C, 101.325 kPa, air			
Protection	IP50			
Fluid compatibility	Non-corrosive			
CE	EN61326-1; -2; -3			

## 8. Technical notes for the product performance

### 8.1 Measurement principle

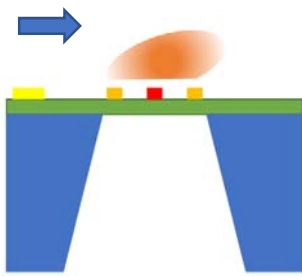

Figure 8.1. Measurement approach illustration.

The products utilize the Company's proprietary micro-machined (MEMS) thermal calorimetric sensing technology. A thermal signal generator (microheater) is placed on a thermally isolated membrane where two thermistors are placed symmetrically concerning the microheater. The flowing fluid carries away the heat from the microheater causing a re-distribution of the temperature field which is registered by the thermistors. The amount of heat carried by the flowing fluid is dependent on the fluid's mass as well as its thermal properties. By precisely gauging the changing of the temperature field with a metrological reference standard, the fluid's mass flow rate can be established and reproduced.

After the circuitry temperature compensation, and with the proper design of the MEMS sensing chip by adding the pressure balancer that allows the flatness of the membrane at various fluidic pressure conditions, the calorimetric thermal sensing will guarantee a pressure and temperature independent mass flow data acquisition. The MEMS technology also allows the mass production of the sensing elements that significantly reduces the cost compared to a traditional thermal mass flow sensing element. It enables the current offer with superior value to the users. For additional information, please refer to the company's US patents and other publications made available to the public.

### 8.2 Precautions for the best performance of the product

#### 8.2.1 Comparison with a third party reference meter

It is very common that a user may compare the data from the product with a third-party reference meter, and in many cases, there could be some discrepancies.

When performing such a comparison, please note that the reference meter should have a better-specified accuracy (about 1/3 of the product), and pay special attention to the differences in the reading accuracy and full-scale accuracy.

A full scale accuracy = reading accuracy x (full scale flow rate/ set point (current) flow rate)



Another key point to compare the different flow meter is that as long as the fluidic flow is a continuous flow without pulsation, then the fluidic dynamic will have the system following the Bernoulli equation:

$$P_1 + \frac{1}{2}\rho v_1^2 + \rho g h_1 = P_2 + \frac{1}{2}\rho v_2^2 + \rho g h_2$$

where  $\rho$  is the fluid density;  $g$  is the acceleration due to gravity;  $P_1$  is the pressure of the reference meter;  $P_2$  is the pressure at the test meter;  $v_1$  is the velocity of the reference meter, and  $v_2$  is the velocity of the test meter.  $h_1$  and  $h_2$  are the corresponding height for the meters which in most cases is the same in the system. Therefore, it would be very critical to have the system does not have a pressure variation. (This explains our recommendations for the installations in Section 4). Also, the meter measurement principle is often very important for the understanding of any discrepancies.

### 8.2.2 Particle contamination and fluidic cleanness

Any contamination including particles and liquid vapors would be detrimental to the accuracy of the flow measurement and also to the meter functionality. It is important to ensure the applied flow medium will be clean and dry. If any contamination is suspected, please allow experienced technical personnel to have it checked and re-conditioned. Do not use a foreign cleanser or other fluids to clean the flow path which could bring irrecoverable damage.

### 8.2.3 Apply to a different gas medium

The product is calibrated with a high precision NIST traceable metrological standard with clean and dry air. In case the meter will be applied to meter the other clean and dry gas, a correct gas conversion factor needs to be registered into the meter before the measurement.

The meter operates similarly to the principle described in the international standard for thermal mass flow meters (ISO 14511:2001 - Measurement of fluid flow in closed conduits — Thermal mass flowmeters). Due to the meter assembled procedure, the head loss value from the meter to the meter would not be 100% identical, and at the large dynamic measurement range, the thermal response would also have some deviations and nonlinearity from gas to gas. Therefore, measurement by the meter for a gas medium other than the calibration gas would bear larger measurement errors, particularly at the low Reynold number range where the laminar flow has a sensitive flow profile.

## 9. Troubleshooting

Phenomena	Possible causes	Actions
No signal / display	Power not connected; battery empty	Connect the power, check the cable
	Cable connection incorrect	Check cable
	No flow or clogging	Check flow and contamination
	Power regulator failure	Return to factory
Sensor failure	Sensor failure	Return to factory
	Large errors or unexpected flowrate	Particles, fluid type
Erroneous or large noise	Vibration, unstable flow	Check system
Valve not work	Wire connection, valve	Return to factory
Offset unstable	Circuitry instability	Check system, power off
No digital interface	Wrong address, software	Check commands, connection
No wireless, BT cannot pair	Wrong model, data jam	Check model, power off/on



## 10. Warranty and Liability

(Effective January 2018)

Tool warrants the products sold hereunder, properly used, and properly installed under normal circumstances and service. As described in this user manual, it shall be free from faulty materials or workmanship for 180 days for OEM products and 365 days for non-OEM products from the date of shipment. This warranty period is inclusive of any statutory warranty. Any repair or replacement serviced product shall bear the same terms in this warranty.

Tool makes no warranty, representation, or guarantee and shall not assume any liability regarding the suitability of the products described in this manual for any purposes that are not specified in this manual. The users shall be held for full responsibility for validating the performance and suitability of the products for their particular design and applications. For any of the misuse of the products out of the scope described herein, the user shall indemnify and hold Tool and its officers, employees, subsidiaries, affiliates, and sales channels harmless against all claims, costs, damages, and expense or reasonable attorney fee from direct or indirect sources.

Tool makes no other warranty, express or implied, and assumes no liability for any special or incidental damage or charges, including but not limited to any damages or charges due to installation, dismantling, reinstallation, etc. other consequential or indirect damages of any kind. To the extent permitted by law, the exclusive remedy of the user or purchaser, and the limit of Siargo's liability for any and all losses, injuries, or damages concerning the products, including claims based on contract, negligence, tort, strict liability, or otherwise shall be the return of products to Tool, and upon verification of Tool to prove to be defective, at its sole option, to refund, repair or replacement of the products. Regardless of form, no action may be brought against Tool more than 365 days after a cause of action has accrued. The products returned under warranty to Tool shall be at the user or purchaser's risk of loss and will be returned, if at all, at Siargo's risk of loss. Purchasers or users are deemed to have accepted this limitation of warranty and liability, which contains the complete and exclusive limited warranty of Tool. It shall not be amended, modified, or its terms waived except by Siargo's sole action.

This manual's product information is believed to be accurate and reliable at the time of release or made available to the users. However, Tool shall assume no responsibility for any inaccuracies and/or errors and reserves the right to make changes without further notice for the relevant information herein.

This warranty is subject to the following exclusions:

- (1) Products that have been altered, modified, or have been subject to unusual physical or electrical circumstances indicated but not limited to those stated in this document or any other actions which cannot be deemed as proper use of the products;

- (2) Products that have been subject to chemical attacks, including exposure to corrosive substances or contaminants. In the case of battery usage, long term discharge or leakage induced damages;
- (3) Products that have been opened or dismantled for whatever reasons;
- (4) Products that have been subject to working conditions beyond the technical specification as described by this manual or related datasheet published by the manufacturer;
- (5) Any damages incurred by the incorrect usage of the products;
- (6) Tools that are not manufacturer's warranty applies, goods manufactured by others. Only the Tool.com manufacturer's warranty applies;
- (7) Products that are re-sold by unauthorized dealers or any third parties.



## 11. Service contact

Tool Ltd. is making every effort to ensure the quality of the products. In case of questions, and or product supports, please contact customer service at the address listed below. We will respond to your request in a timely fashion and will work with you toward your complete satisfaction.



## Appendix I: Product evaluation kit

Tool offers a product evaluation kit, including a digital data converter, USB data cable, and User Application software, that allows the user to evaluate the product performance on a Microsoft Windows-based computer. For some simple applications with digital data transfer, this kit could serve the purpose. The user can read and visualize the flow rate of the product, obtain the totalized values, and save the data for further analysis. It can read from up to 128 sensors with the RS485 interface in serial.

For further information and purchase of the evaluation kit, please contact the manufacturer or the sales representative.

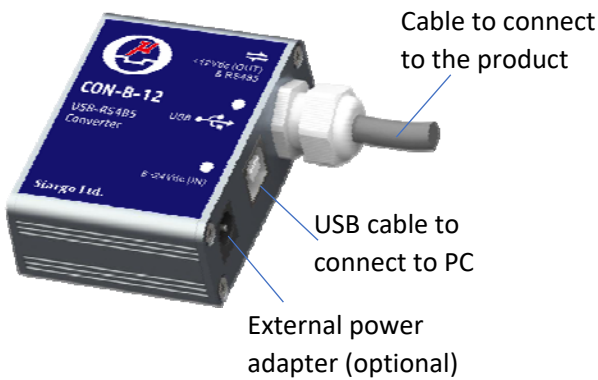

Each converter has a fixed cable that can be directly connected to the product. The USB cable connected to the PC is also included.

For most of the products, the power from the PC via the USB cable will be sufficient to power the sensor product, no external power will be required. However, for multiple sensors in serial, the power via the USB cable may not be enough, an external power adapter with 8~24Vdc will be required.

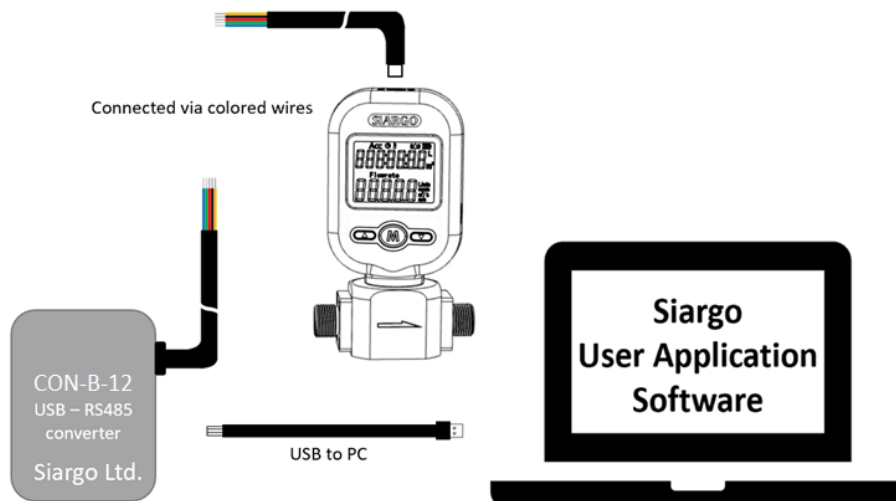

## Appendix II: Document history

Revision C.3 (November 2021)

Added the response time setting.

Corrections.

Revision C.2 (July 2021)

Corrections.

Revision C.1 (March 2021)

The formal release of the 3<sup>rd</sup> generation products.

Revision C.0 (September 2020)

The first release of the 3<sup>rd</sup> generation products.

